



## Steel Security Door Range

---

Our personnel doors are available in sizes from 695mm – 2.2m wide, as single and double steel doors. This versatile range and has applications for a wide variety of uses.

# Affordable security for your home or business

Our steel security door range is available from stock in a huge range of sizes and is fully customisable with options including powder coating, vision & louvre panels, security upgrades, frame extensions, ironmongery and more.

Not only do they all include our industry leading 19 point locking system they also use genuine HOOPLY™ handles & locks as standard.

From stock we also offer Secured by Design certified versions in PAS 24 rated, STS202 BR3 rated and FD120 fire rated doors which offer a maximum of 2 hours of fire protection.

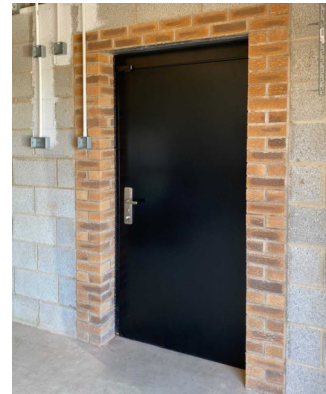

VIEW THE FULL RANGE



**Budget Steel Door**



**Security Steel Door**



**High Security Steel Door**

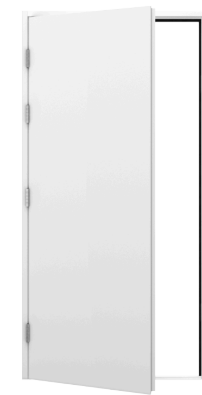

**Blank Steel Door**

<b>DOOR SIZE (MM)</b>	845-995x2020	695-1195x2020 & 910x2065	845-995x2020 & 910x2065	845-995x2020
<b>DOOR DEPTH</b>	45mm Thickness	50mm Thickness	70mm Thickness	50mm Thickness
<b>MATERIAL &amp; GAUGE</b>	0.8mm Galvanised Steel	1.0mm Galvanised Steel	1.2mm Galvanised Steel	1.0mm Galvanised Steel
<b>INT. REINFORCING</b>	None	3 x Reinforced Bars	4 x Reinforced Bars	3 x Reinforced Bars
<b>DOOR &amp; FRAME SEAL</b>	<b>FRAME</b> - Nylon Self Adhesive V-seal		<b>DOOR</b> - Flat Compression Self Adhesive Seal	
<b>FRAME DEPTH</b>	90mm Depth		110mm Depth	90mm Depth
<b>MATERIAL &amp; GAUGE</b>	1.4mm Galvanised Steel	1.8mm Galvanised Steel	2.0mm Galvanised Steel	1.8mm Galvanised Steel
<b>HINGES</b>	3 x S/Steel Ball Bearing Hinges	4 x S/Steel Ball Bearing Hinges	4 x S/Steel Hinges	4 x S/Steel Ball Bearing Hinges
<b>ACOUSTIC RATING</b>	30dB	35dB	38dB	35dB
<b>THERMAL VALUE</b>	2.88W/m2.k	2.2W/m2.k	1.99W/m2.k	2.2W/m2.k



# Versatile stock steel security doors

For larger apertures we have a range of leaf & half and double doors to ensure you find the perfect door to meet your requirements. A wide range of customisation is available to add visibility, ventilation, ironmongery and more.

With security in mind, these doors also include our industry leading multi point locking system with additional concealed shoot bolts to secure the passive leaf in place.

Internally they have up to 8 reinforcement bars and mineral wool insulation.



VIEW THE FULL RANGE

Security Steel Double Door

High Security Steel Double Door

DOOR SIZE	LEAF & HALF - 1295-1395x2020	DOUBLE - 1495-2195x2020 845-995x2020
DOOR DEPTH	50mm Thickness	70mm Thickness
MATERIAL & GAUGE	1.0mm Galvanised Steel	1.2mm Galvanised Steel
INT. REINFORCING	6 x Reinforced Bars	8 x Reinforced Bars
DOOR & FRAME SEAL	<b>FRAME</b> - Nylon Self Adhesive V-seal	<b>DOOR</b> - Flat Compression Self Adhesive Seal
FRAME DEPTH	90mm Depth	110mm Depth
MATERIAL & GAUGE	1.8mm Galvanised Steel	2.0mm Galvanised Steel
HINGES	8 x S/Steel Ball Bearing Hinges	8 x S/Steel Hinges
ACOUSTIC RATING	35dB	38dB
THERMAL VALUE	2.2W/m2.k	1.99W/m2.k

# Stylish security doors to suit your properties aesthetic

Our panelled steel door range includes both 6 panel & cottage style with our industry leading 19 point locking system with genuine HOOPLY™ handles & locks making them not only secure but also aesthetically pleasing to use in your property.

These doors can be fully customised to suit your property with options such as powder coating, vision panels, frame extensions, and more.

From stock we also offer Secured by Design certified versions in PAS 24 rated, STS202 BR3 rated and FD120 fire rated doors which offer a maximum of 2 hours of fire protection.

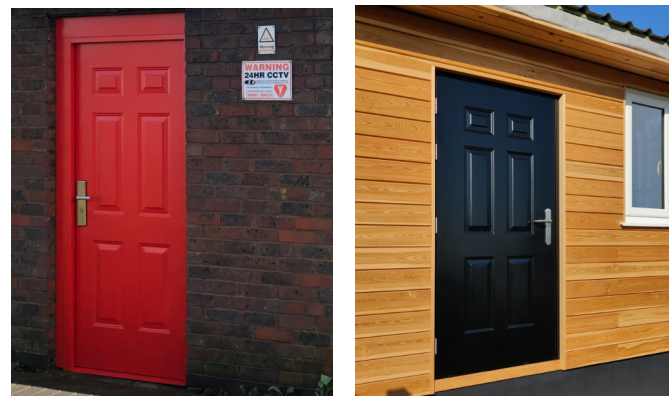

VIEW THE FULL RANGE



Security Panelled Steel Door



Security Cottage Style Steel Door

DOOR SIZE (MM)	845-995x2020	695-1195x2020
DOOR DEPTH	50mm Thickness	
MATERIAL & GAUGE	1.0mm Galvanised Steel	
INT. REINFORCING	3 x Reinforced Bars	
DOOR & FRAME SEAL	<b>FRAME</b> - Nylon Self Adhesive V-seal	<b>DOOR</b> - Flat Compression Self Adhesive Seal
FRAME DEPTH	90mm Depth	
MATERIAL & GAUGE	1.8mm Galvanised Steel	
HINGES	4 x S/Steel Ball Bearing Hinges	
ACOUSTIC RATING	35dB	
THERMAL VALUE	2.2W/m2.k	



# Vision Panels

All of our glazing options include clear laminated glass & anti-tamper vision panels as standard helping increase visibility and improve the reach of light improving your property internal conditions, without compromising on security.

Choose from a range of sizes and positioning options, starting from 225mm x 225mm to 650mm x 1700mm.

For all glazed panels purchased with a door, the frames are powder coated to match. These panels are also sold separately.

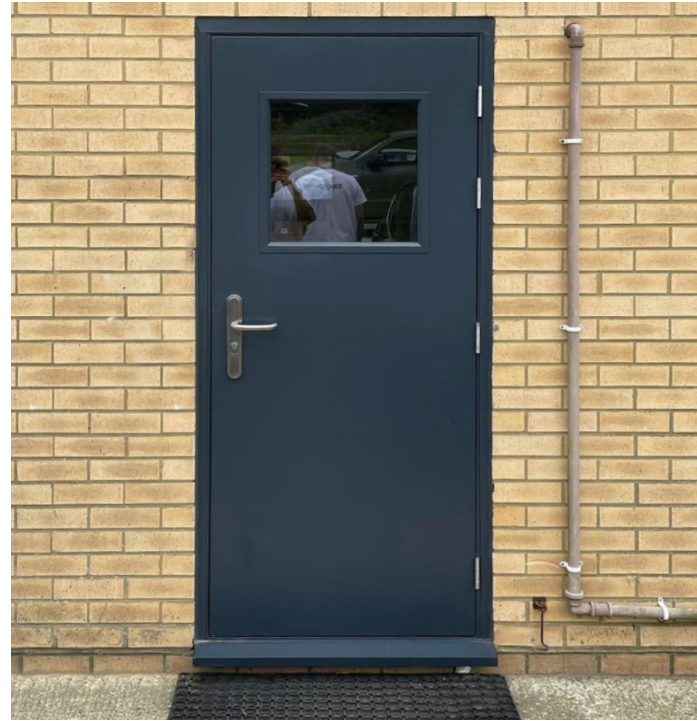

## Vision Panel Sizes

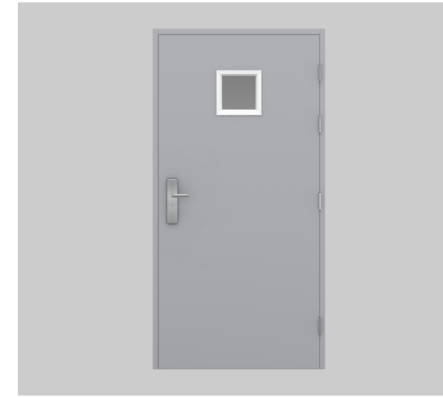

225mm x 225mm

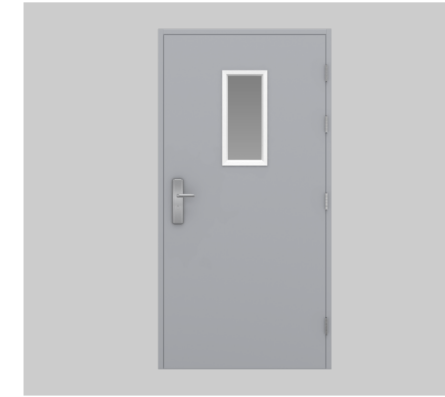

225mm x 530mm



225mm x 1524mm



327mm x 327mm

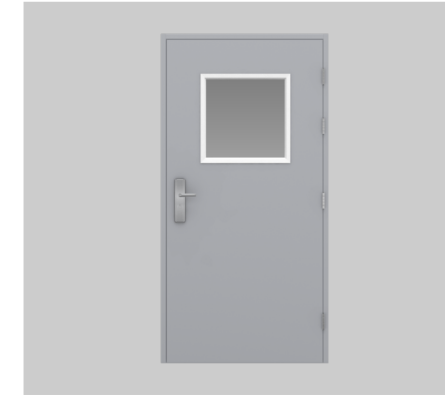

530mm x 530mm



650mm x 800mm  
Half Door



650mm x 1700mm  
Full Door



305mm x 305mm  
Porthole



VIEW THE  
FULL RANGE

# Louvre Panels

Offering up to 50% additional airflow, our louvres are a perfect for use on plant rooms, boiler rooms, bin stores & other applications needing a combination of airflow, ventilation & security.

Ranging in sizes, from as small as 225mm x 225mm to 479mm x 1546mm with a choice of position, create the perfect door to suit your property.

These panels are available to be purchased with a door or separately. When purchasing your louvred panel with a door the panels are powder coated to colour match.



## Louvre Panel Sizes



327mm x 327mm



479mm x 479mm



632mm x 632mm



479mm x 1546mm



225mm x 1546mm

## Additional Options



### Fly Mesh

This is a great additional option you can add onto your louvred doors which ensures flying insects or debris does not enter your property through your louvre panel.



VIEW THE  
FULL RANGE



# Handles

We are the UK's only approved supplier of HOOPLY™ handles, which are compatible with our range of steel security doors, but also commonly used on container doors.

From standard lever handles, to stainless steel security models, HOOPLY™ handles provide unparalleled security at unbeatable value.

We also have blanking plate options that are made in-house which are a great alternative if you only require an interior handle.

The Borg Code Lock option is ideal when you need to control and restrict access to certain individuals.



## Handle Options



Standard Handle  
#5586

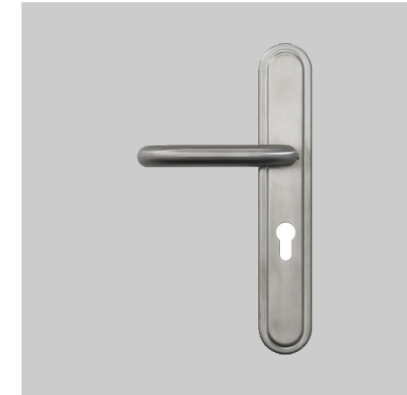

Stainless Steel Handle  
#918901



Stainless Steel Handle  
#918902

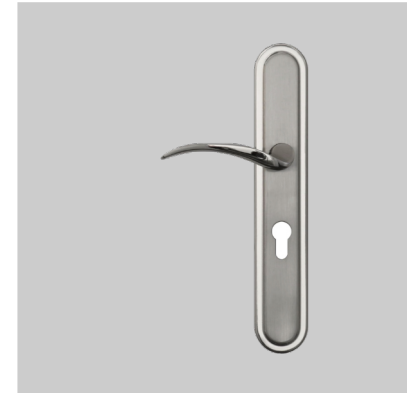

UPVC Style Handle  
#2018



UPVC Style Handle  
#2068



Door Knob  
#2066X

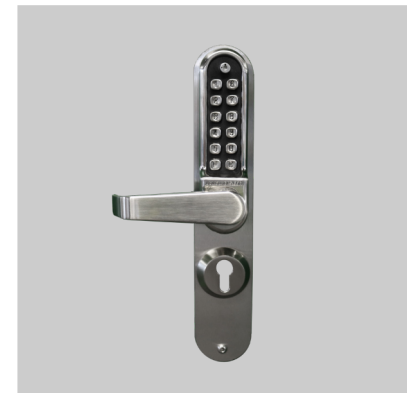

Code Lock



External Blanking Plate\*



External Blanking Plate with key  
access\*

\* Blanking plates are supplied white as standard, or if your door is being powder coated it can be coloured to match



VIEW THE  
FULL RANGE

# Doors that can fit any aperture

If one of our standard sizes doesn't quite suit your requirements, we have a variety of extension panel options to help fit your opening, ensuring a easy installation process and a seamless completed look to your property.

Whether your opening requires a 5mm extension or a 1000mm extension, our frame extensions can ensure the door fits perfectly to your property while still looking stylish and modern.

Over head and expanding side panels are available in a range of standard sizes from stock, and are powder coated to match when purchased with a door.

## Over Head Panel



**Sizes Available: +25-300mm or custom size**

Our over head panels are a far stronger alternative to using timber or another form of packing. Manufactured from 1.5mm steel and powder coated white as standard or to match the colour of your door.

## Expanding Side Panel



**Sizes Available: +5-40mm , +50-85mm**

Our expanding side panels use wind out lugs that screw into pre-threaded holes at the fixing plate positions. These panels can ensure the door is fitted without any required form of packing.

## Frame Extensions

Our frame extensions can extend your door width and height up to an additional 150-1000mm. As these are made to order it can take up to 10 working days from order date plus delivery time.



### Solid Frame Extension

Our solid frame extensions are a great way to give your property a flush finish. These panels are fully insulated with Rockwool infill & are available in stock white or powder coated to match the colour of your frame.

Height: 150-1000mm

Width: 150-1000mm



### Glazed Frame Extension

Our glazed frame extensions are fully insulated, can be powder coated to match your door frame & has laminated toughened double glazing allowing additional natural light to pass through whilst still keeping your property secure.

Height: 150-1000mm

Width: 150-1000mm

Glass Type: Clear, Satin (Opaque) & Cotswold Effect



### Louvred Frame Extension

Our louvred frame extensions are designed for applications that require constant airflow such as bin rooms, plant rooms & industrial units. These are supplied in stock white with the option to powder coat to match your door.

Height: 150-1000mm

Width: 150-1000mm

Airflow: Up to 50%



# Upgrade your doors to the best security

We offer security upgrades on our doors to allow you to increase security, with a budget in mind. Our security upgrade options include some different components at the main lock and handle of the door.

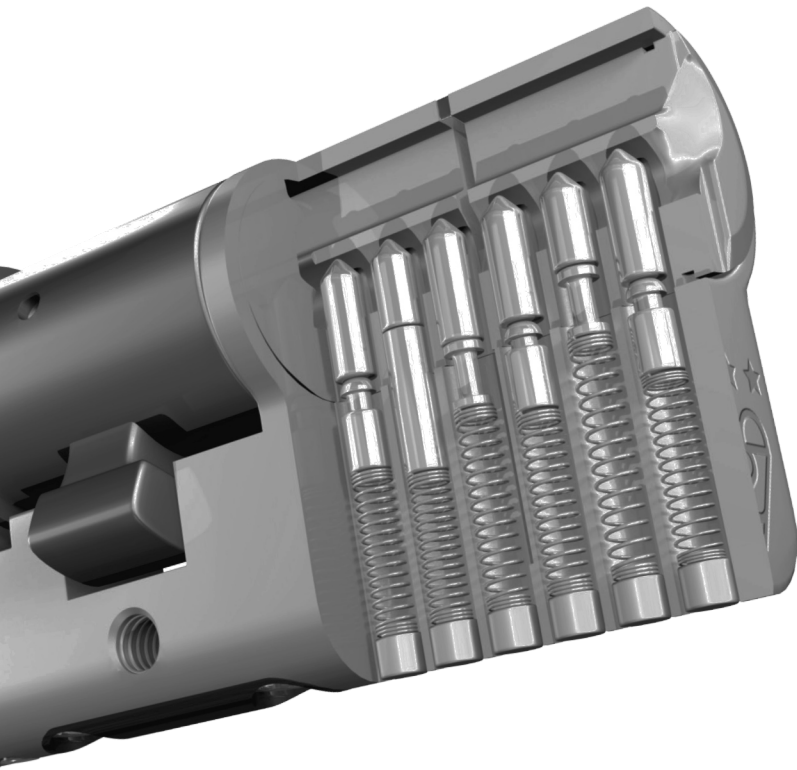

**UAP Kinetica  
3\* Kitemarked Cylinder**

## Cast Cylinder Covers



Our high security stainless steel cylinder cover ensures the cylinder is protected and it has been designed to fit perfectly with our HOOPLY™ handle range.

## Stainless Steel Handles



Our security upgrade handles are made from heavy duty stainless steel material making them robust & long lasting. In addition, these genuine HOOPLY™ handles feature an anti drill euro cylinder cover.

## 3\* Kitemark Cylinder



Our 3\* Kitemark Cylinder has enhanced security features and has anti tilt technology blocking access to the bolt during an attack.



Anti-Snap



Anti-Drill



Anti-Bump



Anti-Pick

## Additional Upgrades



### Drop Bar Kit

For additional security you can add a drop-bar kit. This kit consists of 4-8 brackets (colour matched to your door), 2 drop bars (Traffic Yellow) and fixings. Easy to fit, they are suitable for both inward or outward opening doors.



### Security Trim

The security trim will protect your property as well as give it a professional finished look. This kit is fast and easy to fit, protects your fixings from attack and eliminates the risk of tampering.



### Tower Bolt

Our heavy duty tower bolt has been designed for use on fire escape doors to complement the EXIDOR™ panic furniture. These add an extra level of security to your door by bolting into the frame.



**LATHAM'S<sup>®</sup>**  
STEEL SECURITY DOORSETS



35/37 Hainge Road, Tividale, Oldbury,  
West Midlands, B69 2NY



01384 220050



[sales@lathamssteeldoors.co.uk](mailto:sales@lathamssteeldoors.co.uk)



[www.lathamssteeldoors.co.uk](http://www.lathamssteeldoors.co.uk)

